

## Film Chip Capacitor

Type: **ECP(U)B**

Stacked dielectric and inner electrode with simple mold-less construction



### ► Features

- Low ESR
- Max. capacitance values 1.0μF
- Smallest package size in film capacitors 3216/1.0μF
- Applicable for reflow soldering

### ► Recommended Applications

- Noise suppressor
- Coupling circuit for Audio

### ► Explanation of Numbers

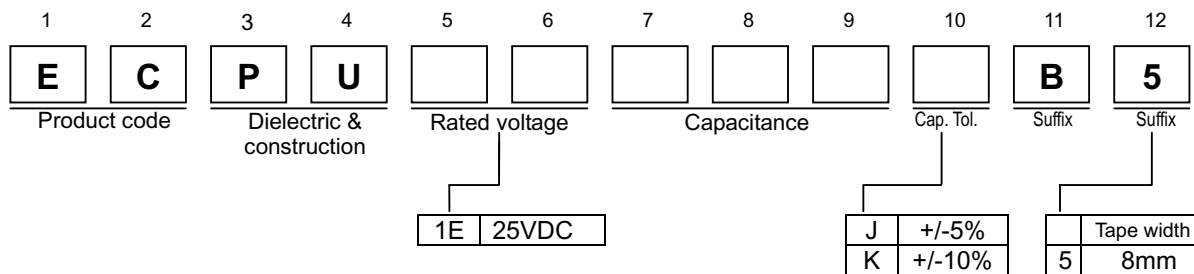

### ► Specification

Category temp.range	-40 to +105 degree C
Rated voltage	25VDC
Capacitance range	0.01μF to 1.0μF (E12)
Capacitance tolerance	+/-5%(J), +/-10%(K)
Withstand voltage	Between terminals : Rated volt. (VDC)X150% , 1min
Dissipation factor	1.5% max. (20 degree C , 1kHz)
Insulation resistance	0.010μF - 0.33μF : 1000MΩ min. (20 degree C , 25VDC , 60s) 0.39μF - 1.0μF : 300MΩ· μFmin. (20 degree C , 25VDC , 60s)
Soldering conditions	Reflow soldering : 250 degree C max. and 30s max. at more than 220 degree C (Temp. at cap. Surface)

### ► Construction

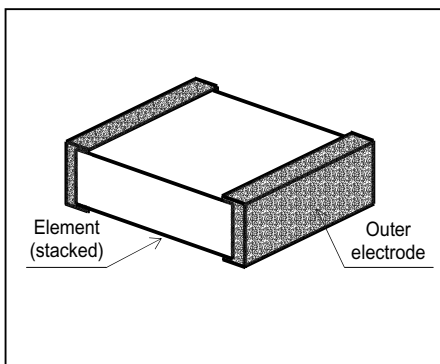

### ► Dimensions in mm (not to scale)

Size code	L	W	H	e	g
K0	1.6	0.8	0.6	0.40	min.0.4
J1	2.0	1.25	0.8	0.45	min.0.6
J2	2.0	1.25	1.0	0.45	min.0.6
H1	3.2	1.6	0.8	0.65	min.1.0
H2	3.2	1.6	1.0	0.65	min.1.0
H3	3.2	1.6	1.4	0.65	min.1.0

\* To be applied only for size code J1 & J2  
\*\* To be applied only for size code K0

- ▶ Rating , Dimensions & quantity / Reel
- Capacitance tolerance : +/- 5%(J), +/- 10%(K),

Cap. ( $\mu$ F)	Rated volt. 25VDC					Q'ty
	Part No.	Dimensions (mm)			Size code	
		L	W	H		
0.01	EPCU1E103( )B5	1.6	0.8	0.6	K0	4000
0.012	EPCU1E123( )B5	1.6	0.8	0.6	K0	
0.015	EPCU1E153( )B5	1.6	0.8	0.6	K0	
0.018	EPCU1E183( )B5	1.6	0.8	0.6	K0	
0.022	EPCU1E223( )B5	1.6	0.8	0.6	K0	
0.027	EPCU1E273( )B5	1.6	0.8	0.6	K0	
0.033	EPCU1E333( )B5	1.6	0.8	0.6	K0	
0.039	EPCU1E393( )B5	1.6	0.8	0.6	K0	
0.047	EPCU1E473( )B5	2.0	1.25	0.8	J1	3000
0.056	EPCU1E563( )B5	2.0	1.25	0.8	J1	
0.068	EPCU1E683( )B5	2.0	1.25	0.8	J1	
0.082	EPCU1E823( )B5	2.0	1.25	0.8	J1	
0.1	EPCU1E104( )B5	2.0	1.25	1.0	J2	
0.12	EPCU1E124( )B5	2.0	1.25	1.0	J2	
0.15	EPCU1E154( )B5	2.0	1.25	1.0	J2	
0.18	EPCU1E184( )B5	3.2	1.6	0.8	H1	
0.22	EPCU1E224( )B5	3.2	1.6	0.8	H1	
0.27	EPCU1E274( )B5	3.2	1.6	0.8	H1	
0.33	EPCU1E334( )B5	3.2	1.6	0.8	H1	
0.39	EPCU1E394( )B5	3.2	1.6	0.8	H1	
0.47	EPCU1E474( )B5	3.2	1.6	1.0	H2	
0.56	EPCU1E564( )B5	3.2	1.6	1.0	H2	
0.68	EPCU1E684( )B5	3.2	1.6	1.4	H3	2000
0.82	EPCU1E824( )B5	3.2	1.6	1.4	H3	
1.0	EPCU1E105( )B5	3.2	1.6	1.4	H3	

▶ Example for Land Dimensions (mm)

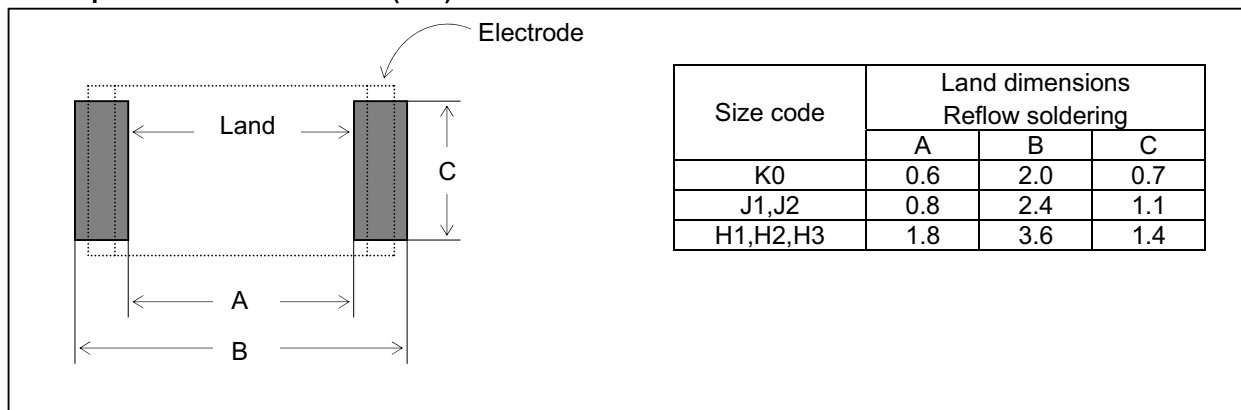

## EPCU (B) Type DC25V series (Stacked Metallized Film)

### Electrical Characteristics < Typical Data >

#### Temperature Characteristics

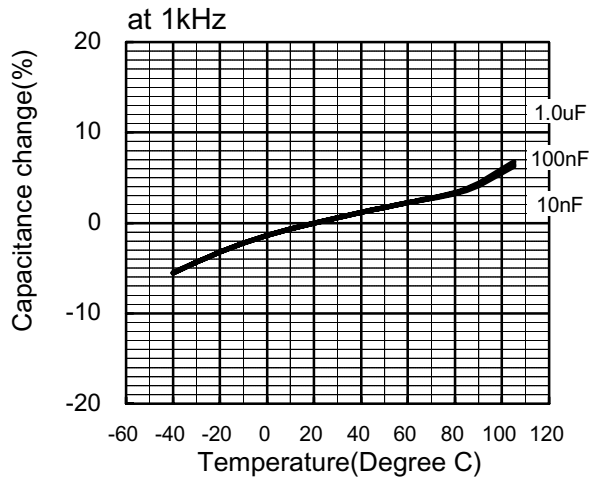

#### Frequency Characteristics

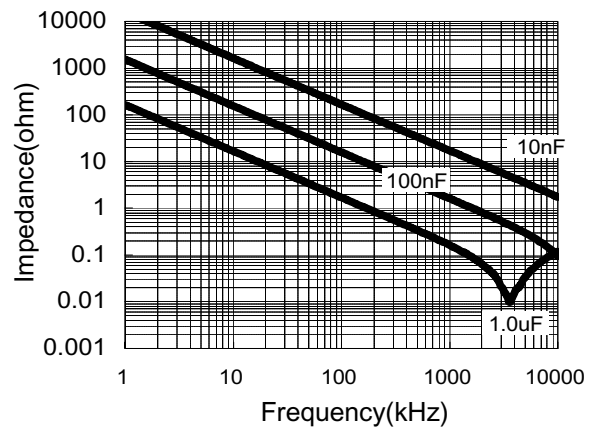
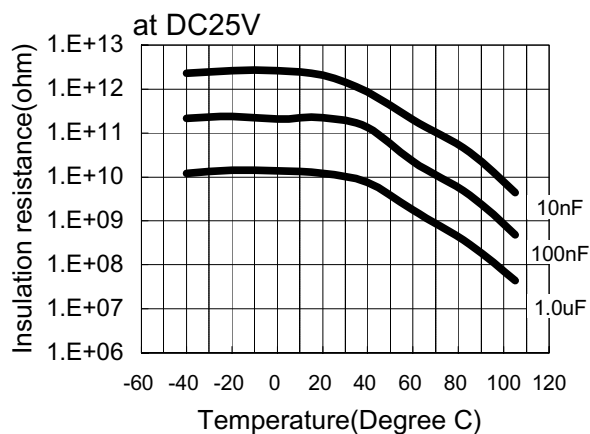
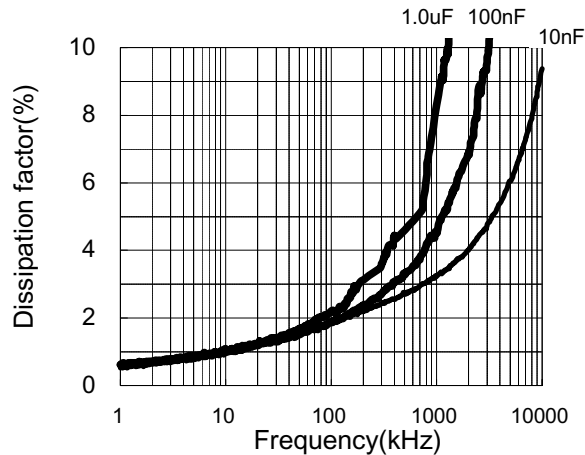
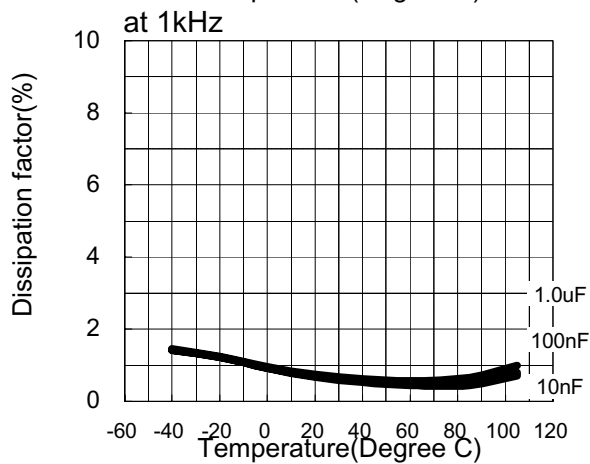
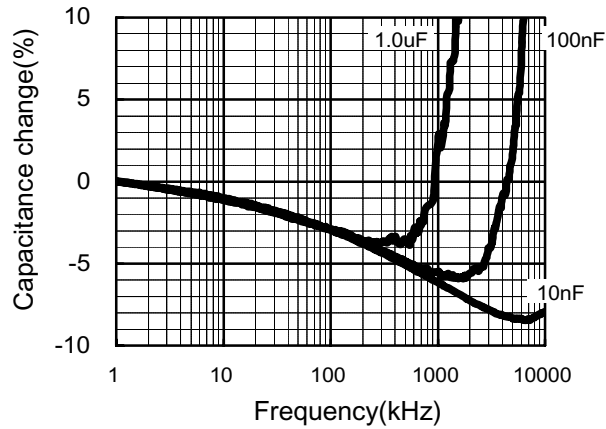

## EPCU (B) Type DC25V series (Stacked Metallized Film)

### Applicable Specifications

#### Permissible Current

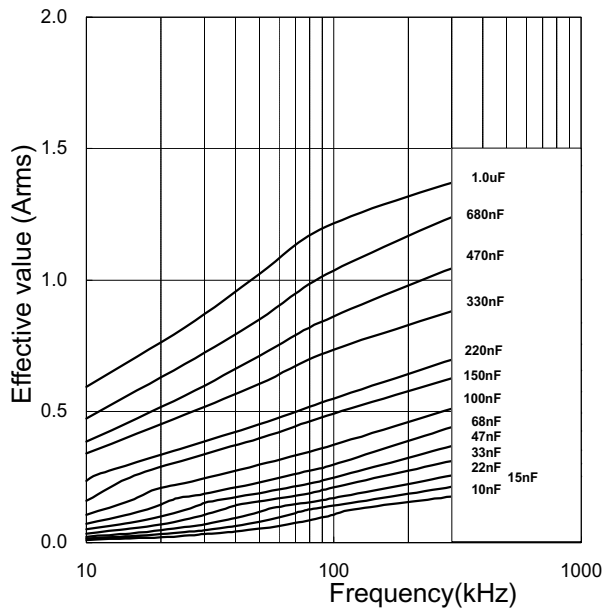

#### Permissible Voltage

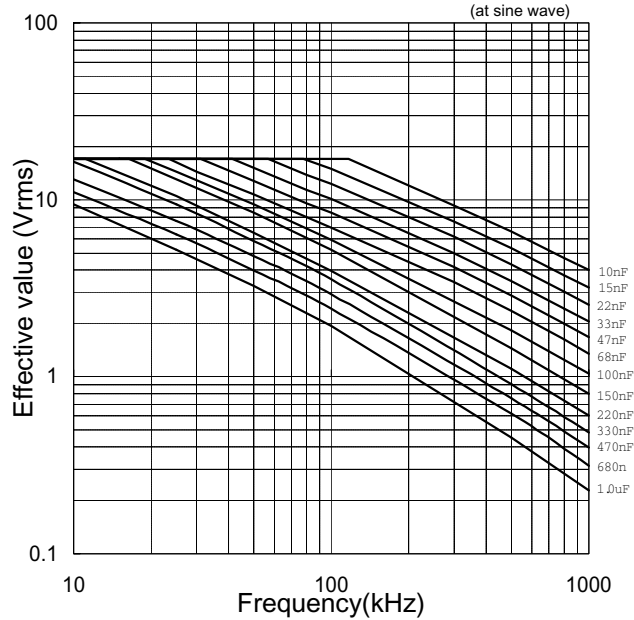

#### Pulse Handling Capability (dv/dt) (Max 10000cycles)

Rating Voltage	Capacitance Value(uF)	code	dV/dt (V/us)	Current(0-P) (A)
DC 25V	0.01	103	65	0.65
	0.012	123	58	0.70
	0.015	153	50	0.75
	0.018	183	47	0.85
	0.022	223	40	0.88
	0.027	273	37	1.00
	0.033	333	33	1.09
	0.039	393	30	1.17
	0.047	473	27	1.27
	0.056	563	25	1.40
	0.068	683	23	1.56
	0.082	823	21	1.72
	0.10	104	19	1.90
	0.12	124	17	2.04
	0.15	154	15	2.25
	0.18	184	13	2.34
	0.22	224	12	2.64
	0.27	274	11	2.97
	0.33	334	10	3.30
	0.39	394	8	3.12
0.47	474	7	3.29	
0.56	564	6	3.36	
0.68	684	5	3.40	
0.82	824	4	3.28	
1.00	105	3	3.00	

#### Voltage Derating by Temperature

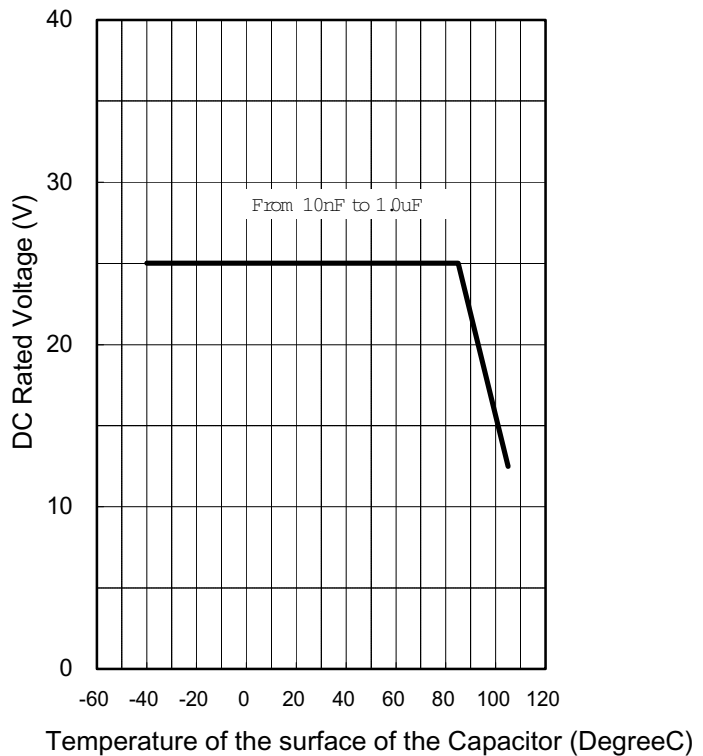

\* Please consult Panasonic if your condition exceeds the above

\*Permissible voltage graph is the case of sine waveform. When you use this product, peak voltage must not exceed DC rated voltage.

\*The current(0-P) value is calculated using nominal capacitance.

## (1) Stable Temp. Characteristics

**【 Temperature Characteristics 】**

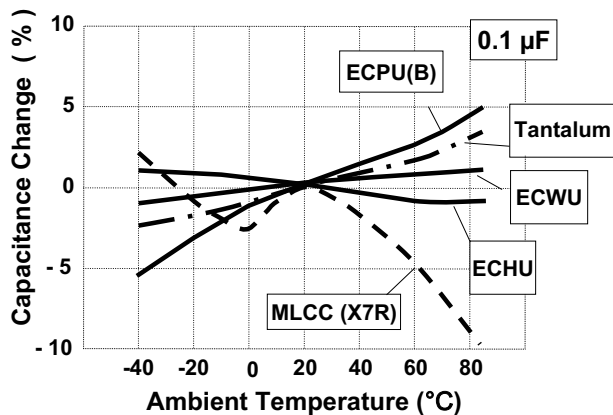

## (2) Low Dielectric Absorption

**【 Dielectric Absorption Data 】**

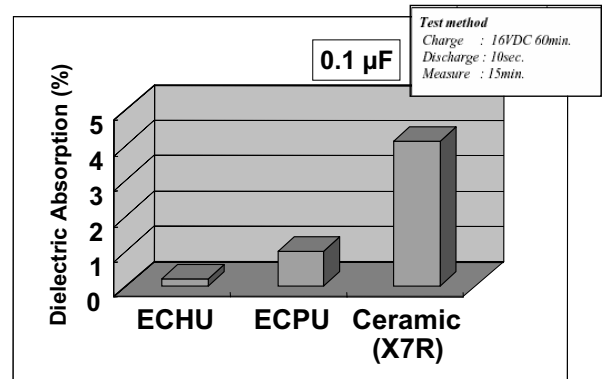

### Target Application:

- Time Constant/Filtering Circuit
  - Application circuit performs stably due to stable electrical characteristics of Film Capacitor.

### Target Application:

- Lag Lead Filter in PLL Circuit
  - Faster Lock Up Time.
- Integral Circuit in Servo
  - Better Linearity and Response.

## (3) Low ESR

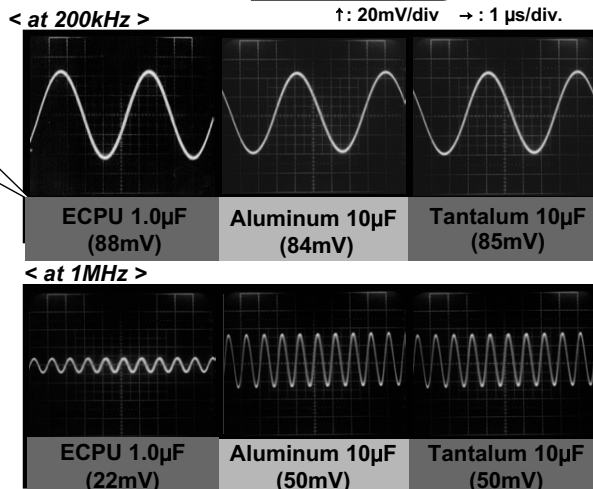
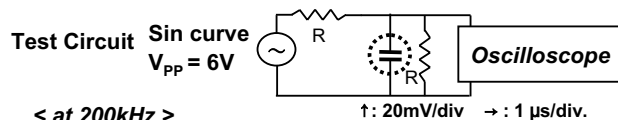
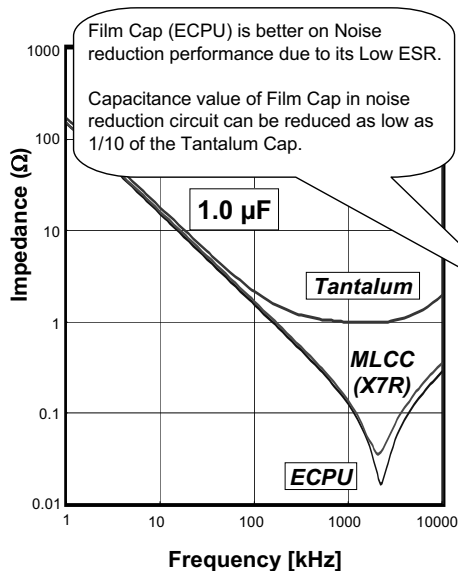

## (4) No Capacitance change vs. DC Bias Voltage change

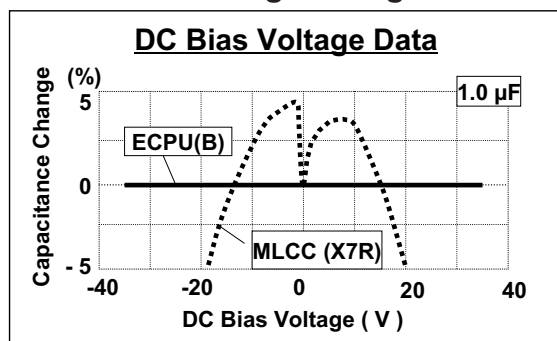

Capacitance Value of MLCC X7R changes by DC Bias Voltage Change due to Piezoelectric effect.

Capacitance value of Film Capacitor does not change due to None Piezoelectric Effect.

## (5) Low Distortion

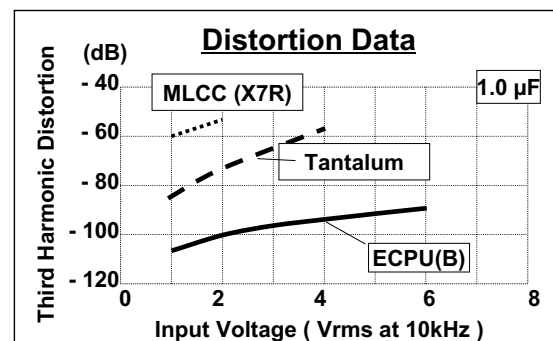

Distortion level of Film Capacitor is lower than the other capacitors due to characteristics of Dielectric Film.

Using Film Capacitor can be solution of phase noise problem.

### (6) No Shock Noise

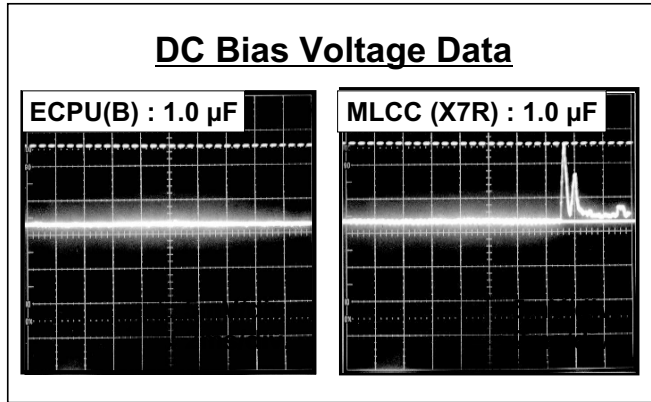

When a printed circuit board is subjected to mechanical shock, an MLCC X7R generates Shock Noise due to Piezoelectric effect.

Film Capacitors do not exhibit this undesirable phenomenon.

### (7) No Buzz Noise

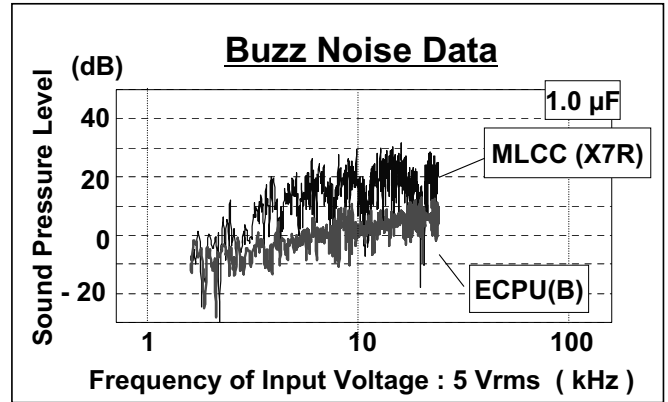

MLCC X7R sometimes generate Buzz when used in AC circuit due to Piezoelectric effect.

Using Film Capacitors can be a solution to the Buzz Noise problem.

### (6) Sound quality can be improved by using Film Capacitors

